



**Float valves**  
**Male thread • For large storage tanks**  
**Brass und Stainless steel**

Float valves of our series RSV are always used when extremely robust valves for elevated supply pressures and/or high flow rates are required.

Series RSV O and RSV G are specially suited for drinking water. All models comply with the rigid European Drinking Water Regulation and DIN 1717 and are DVGW- and KIWA-certified. For this reason, both series are ideally suited for all applications which require a connection to the drinking water system (e.g. pressure boosters, fire protection systems etc.).

Due to the specific lever transmission these valves get along with relative short stems. The seal can be inspected and exchanged without dismantling the valve. All valves are entirely made of brass or stainless steel (RSV VA). Matching floats are available either made of copper or stainless steel (V4A).

**Customs tariff number**.....

84818081



**Media** .....

The float valves of the series RSV G and RSV O are suitable for the use of drinking water and other neutral, non-sticky liquids.

The stainless steel float valve RSV VA is suitable for the use with aggressive water and liquids

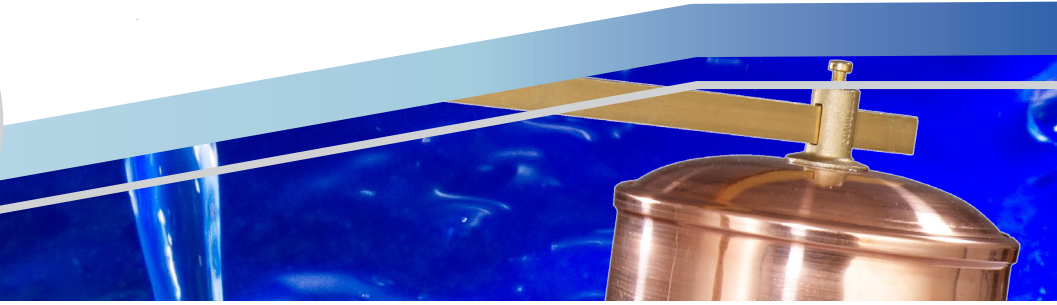

## Features

- male thread according ISO 228
- max. working pressure 12 bar
- RSV O with DVGW approval
- RSV G with KIWA approval
- replaceable valve seat
- elaborated lever construction
- dirt-resistant control flap
- connection for immersion pipe (RSV G)
- robust design
- floats optionally in copper or stainless steel
- float arm can be shortened

## Working pressure



max. 12 bar

## Connections



Male thread  
acc. ISO 228  
from G 3/8" up to G 3"

## Materials

	body	wetted parts	float arm	cap	seals	max. temperature
RSV O	brass	brass	brass	brass	EPDM	130 °C*
RSV G	brass	brass	brass	brass	EPDM	130°C*
RSV VA	stainless steel 1.4571	stainless steel 1.4404	stainless steel 1.4571	stainless steel 1.4571	FKM	190°C



## Temperatures

Various options in the area of seals and internal parts in contact with the medium allow a maximum temperature of up to 190°C.



from 0 °C up to +190 °C

## Seals and temperatures

EPDM 0°C to +130°C \*  
FPM 0°C to +190°C

\* in combination with CU-floats max. 80°C

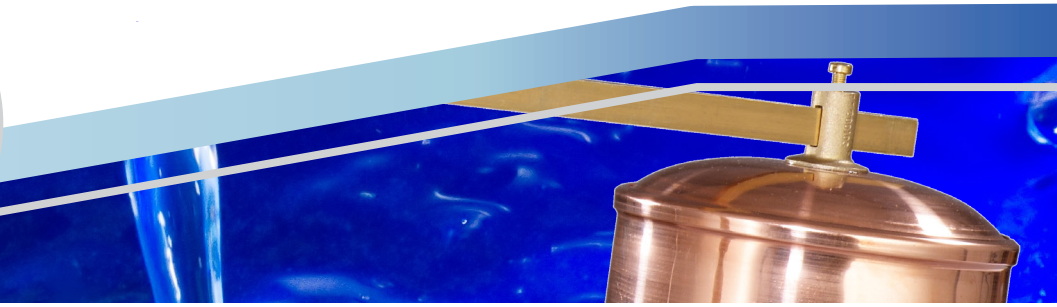

**Technical data**

nominal size	10	15	20	25	32	40	50	65	80
G	3/8"	1/2"	3/4"	1"	1 1/4"	1 1/2"	2"	2 1/2"	3"

**Pressures**

max. 12 bar



max. working pressure [bar]

RSV O	12
RSV G	12
RSV VA	12

**Connections**

Male thread  
from G 3/8" to G 3"



dimensions [mm]

	G1	3/4"	3/4"	1"	1 1/4"	1 1/2"	1 3/4"	2"	2"	2"
RSV O	L	393	524	543	618	692	750	877	1013	1014
	L1	33	41	42	46	44	45	50	79	79
RSV G	L	408	510	542	630	730	800	960	985	985
	L1	40	40	42	47	45	46	51	70	70
RSV VA	L	--	523	572	654	720	772	885	952	--
	L1	--	49	40	45	45	45	51	71	--

weight [kg]

RSV O	0,9	1,4	1,8	2,7	4,1	4,9	7,1	11,5	12,5
RSV G	1,0	1,1	1,7	2,6	3,5	4,6	7,9	9,0	10,0
RSV VA	--	1,3	1,4	1,6	2,7	2,8	4,8	6,0	--

kvs-value [m³/h]

RSV O	0,6	1,8	3,8	7,6	14	23	34	47	47
RSV G	2,1	2,3	5,3	7,5	11	16	18	40	40
RSV VA	--	1,9	3,7	5,6	11	14	23	34	--

dimensions float [mm]

Kupfer	D	153	153	174	209	232	257	308	353	353
	H	116	116	128	172	199	221	254	285	285
Edelstahl	D	--	179	246	200	240	240	280	305	305
	H	--	90	107	200	180	240	280	305	305

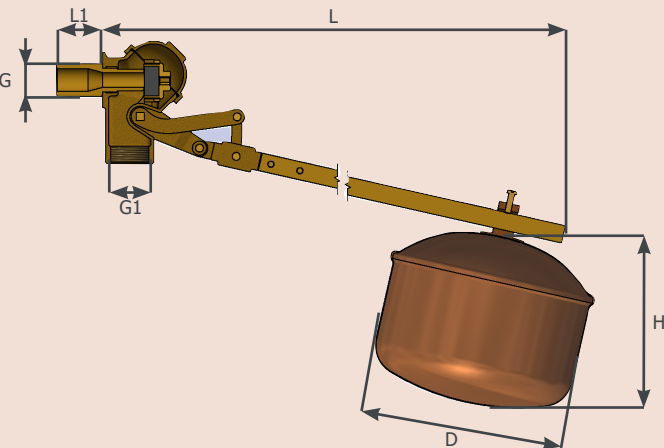

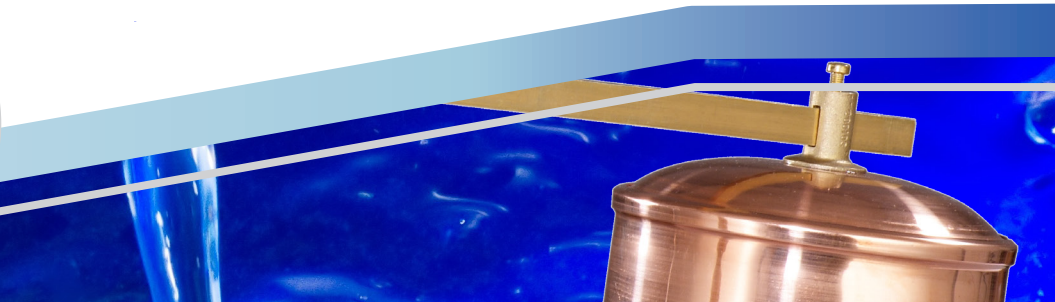

Article number

nominal size	10	15	20	25	32	40	50	65	80
G	3/8"	1/2"	3/4"	1"	1 1/4"	1 1/2"	2"	2 1/2"	3"

standard version

RSV O	000401	000402	000403	000404	000405	000406	000407	000408	000409
RSV G	000501	000502	000503	000504	000505	000506	000507	000508	000509
RSV VA	--	000302	000303	000304	000305	000306	000307	000308	--

float

copper	000802	000802	000803	000804	000805	000806	000807	000808	000808
stainless steel - V4A	--	000842	000843	000844	000845	000846	000847	000848	000848

Flow diagram

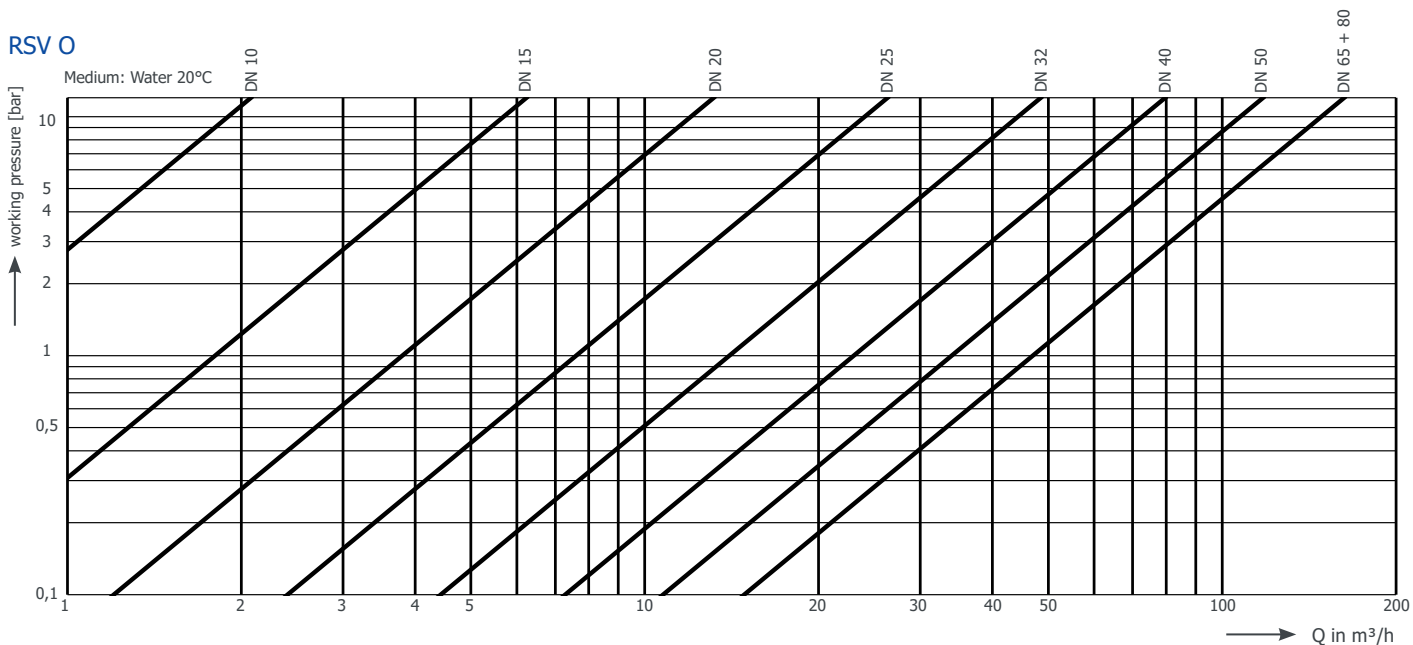

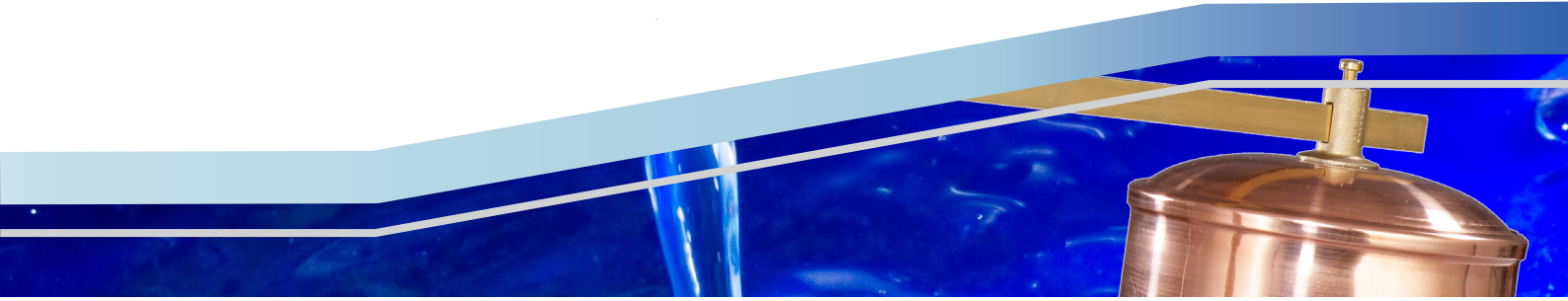

**RSV G**

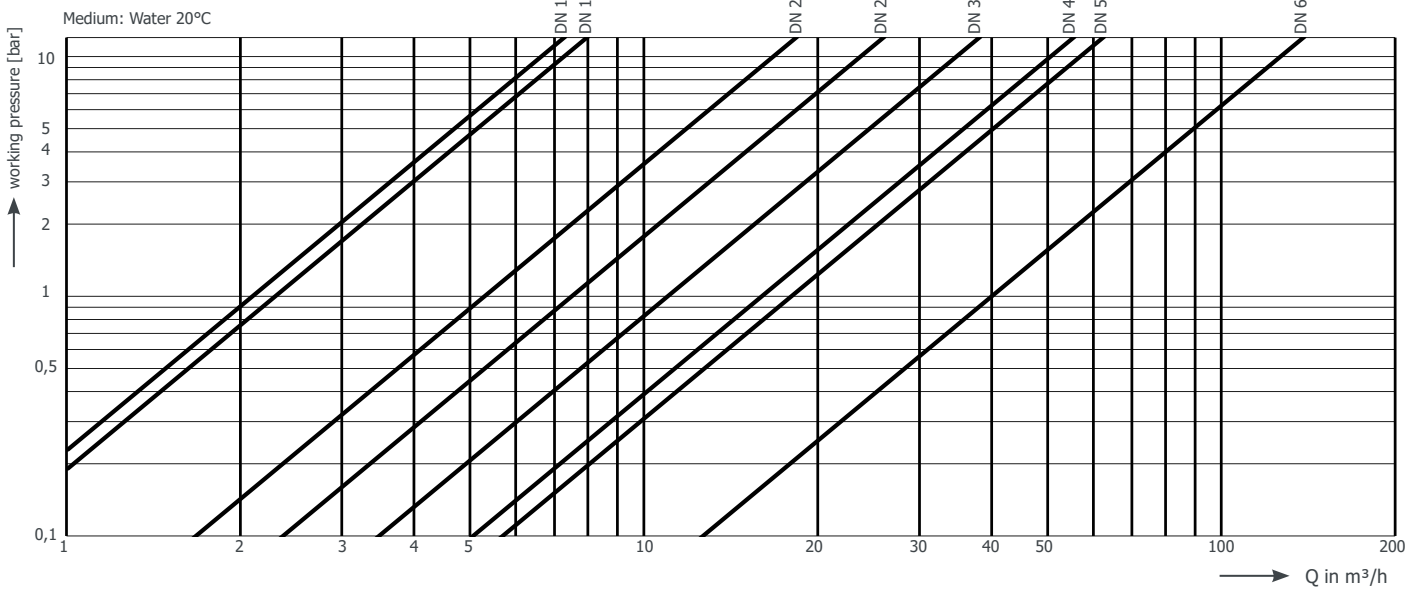

**RSV VA**

